

ÍNDICE

SISTEMA ALIMENTACIÓN Y FILTRACIÓN	PÁG
BOMBAS DE COMBUSTIBLES MANUALES	306
FILTROS DE COMBUSTIBLE	307
BRACKETS	307
CONECTORES Y MANGUERAS COMBUSTIBLE	306
KIT DE CARBURADOR	318
JUNTAS ADMISIÓN	318
SISTEMA ELÉCTRICO	PÁG
DESCONECTADORES DE SEGURIDAD	315
MOTORES DE ARRANQUE	312
MOTORES DE TRIM Y POWER TRIM	313
REGULADORES Y RECTIFICADORES	314
ALTERNADOR	314
SENSOR DE OXÍGENO	314
SENSOR ÁRBOL DE LEVAS	314
SISTEMA DE ENCENDIDO	PÁG
BOBINAS	314
BUJIAS CHAMPION	316
BUJIAS NGK	315
SISTEMA DE REFRIGERACIÓN	PÁG
IMPULSORES	319
KIT REPARACIÓN BOMBA DE AGUA	321
JUNTAS DE COLA	321
KIT JUNTAS Y RETENES	321
TERMOSTATO	317
PARTES DE MOTOR	PÁG
JUNTAS BASE DE MOTOR	316
JUNTAS DE CULATA	316
JUNTAS ESCAPE	317
CORREAS DE DISTRIBUCIÓN	317
RETÉN DE VÁLVULAS	317
COLAS Y COMPONENTES	PÁG
ÁNODOS ZINC Y ALUMINIO	311
RETENES COLA	322
HELICES Y GUÍA DE APLICACIÓN	325
FILTROS ACEITE	310
GUÍA FILTROS ACEITE	310
DESPIECE COLA	320
JUNTAS BOMBA AGUA	322
COMPONENTES TRANSMISIÓN	323

TABLE OF CONTENTS

FUEL & FILTRATION SYSTEM	PAGE
PRIMER FUEL PUMP	306
FUEL FILTERS	307
BRACKETS	307
HOSES & FUEL FITTINGS	306
CARBURETOR KIT	318
ADMISION GASKET	318
ELECTRIC SYSTEM	PAGE
CUT OFF SWITCHES	315
STARTERS	312
TRIM & POWER TRIM	313
REGULATOR & RECTIFIERS	314
ALTERNATOR	314
O2 SENSOR	314
SENSOR CRAMSHAFT	314
IGNITION SYSTEM	PAGE
COILS	314
CHAMPION SPARK PLUGS	316
NGK SPARK PLUGS	316
COOLING SYSTEM	PAGE
IMPELLERS	319
WATER PUMP SERVICE KITS	321
DRIVE GASKET	321
LOWER UNIT SEAL KITS	321
THERMOSTAT	317
ENGINE PARTS	PAGE
GASKET ENGINE HOLDER	316
GASKETS CYLINDER HEAD	316
EXHAUST GASKET	317
TIMMING BELTS	317
VALVE SEALS	317
UNIT DRIVES & COMPONENTS	PAGE
ZINC & ALUMINIUM ANODES	311
OIL SEALS	322
PROPELLERS & APPLICATION GUIDE	325
OIL FILTER	310
OIL FILTER GUIDE	310
COMPLETE GEARCASE ASSEMBLY	320
WATER PUMP GASKET	322
GEAR COMPONENTS	323

INDICE

SISTEMA DI ALIMENTAZIONE E FILTRAZIONE	PAGINA
POMPE DI CARBURANTE MANUALE	306
FILTRI BENZINA	307
BRACKETS	307
ATTACCO E TUBO BENZINA	306
KIT CARBURATORE	318
GUANIZIONE ASPIRAZIONE	318
SISTEMA ELETTRICO	PAGINA
CHIAVETTA DI SICUREZZA	315
MOTORINI AVVIAMENTO	312
MOTORINI TRIM E TRIM POWER	313
REGOLATORI E RADRIZZATORI	314
ALTERNATORE	314
SENSORI OSSIGENO	314
SENSORE ALBERO	314
SISTEMA DI ACCENSIONE	PAGINA
BOBINE	314
CANDELE CHAMPION	316
CANDELE NGK	316
SISTEMA DI RAFFREDDAMENTO	PAGINA
GIRANTE	319
KIT RICAMBI POMPA ACQUA	321
GUARNIZIONI PIEDI	321
KIT GUARNIZIONE E PARAOLIO PIEDE	321
THERMOSTATO	317
PARTI DEL MOTORE	PAGINA
GUARNIZIONI BASE MOTORI	316
GUARNIZIONE TESTATA	316
GUANIZIONE SCARICO	317
CINGHIE DISTRIBUZIONE	317
TENUTE	317
PIEDI E COMPONENTI	PAGINA
ANODI ZINCO E ALLUMINIO	311
PARAOLIO	322
ELICHE E GUIDA APPLICAZIONE	325
FILTRI OLIO	310
GUIDA FILTRI OLIO	310
ESPLOSO PIEDE	320
GUARNIZIONE POMPA ACQUA	322
COMPONENTE TRASMISSIONE	323

CONECTORES COMBUSTIBLE FUEL FITTINGS ATTACCHI BENZINA

BOMBA DE COMBUSTIBLE PRIMER BULB POMPA BENZINA

Ref.	Manguera Hose Tubo	Envase Pack Qnt
GS31090	5/16"	1 x blister
GS31095	3/8"	1 x blister
GS31187	1/4"	1 x blister
CEF500621	8 mm	1 x bolsa / bag / borsa



GOLDENSHIP

Universal / Universale
GS31090 - GS31095- GS31187

Fabricada con elastómeros termoplásticos inyectados, resistentes al alcohol y rayos UV.

Premium quality bulb resistance to alcohol as well as UV and ozone.
Fabbricata con elastomero termoplastico, resistente ai solventi e ai raggi UV.



CEF500621

LÍNEA DE COMBUSTIBLE FUEL LINE ASSEMBLY TUBO CARBURANTE

Ref.	R.O. OEM	Manguera Hose Tubo	Envase (x bolsa) Pack (x bag) Qnt (x borsa)
GS31096		5/16"	1
GS31097		3/8"	1
GS31099		8 mm	1
SIE-18-8013		5/16"	1
SIE-18-8015		3/8"	1
CEF500600		8 mm	1

Universal. Con 2 m de manguera resistente al alcohol.

Universal. With 2 m alcohol resistant hose.

Universale con 2 m di tubo resistente ai solventi.

GOLDENSHIP



GS31096 - GS31097



GOLDENSHIP

GS31099



SIE-18-8013, SIE-18-8015



CEF500600

Ref.	R.O. OEM	Manguera Hose Tubo	Envase (x bolsa) Pack (x bag) Qnt (x borsa)
GS31189		3/8"	1

GOLDENSHIP



Bomba GS31188.

Con 2 m de manguera resistente al alcohol.

Primer GS31188. With 2 m alcohol resistant hose.

Pompa GS31188 con 2 m di tubo resistente ai solventi.

MANGUERA DE COMBUSTIBLE FUEL HOSE TUBO BENZINA

Ref.	Ø Int	Largo Lengh Long	Envase Pack Qn
TRI305-0566	5/16" = 7,92 mm.	15 m	Caja / Box / Cassa
TRI305-0386	3/8" = 9,53 mm.	15 m.	Caja / Box / Cassa



Manguera «Trident» para líneas de combustible. Con refuerzo termoplástico que le permite excelente flexibilidad y resistencia a los rayos UV. Color gris. Resistente al alcohol. **Especialmente indicado para motores fueraborda.** Cumple las normas: SAEJ1527, ISO-8469 Tipo B1 y Certificación CE.

Garantía: 3 años

Marine fuel hose (distribution and vent) for outboards. Fuel resistant thermo-plastic formulation with 2 spiral reinforcement provides excellent bendability and resistance to UV, aging and permeation by all marine fuels (gasoline/petrol and diesel) including alcohol blends.

Meets or exceeds: SAEJ1527, ISO-8469 Tipo B1 & Certification CE.

Warranty: 3 years

Tubo «Trident» per linea combustibile. Con rinforzo termoplastico che gli permette un'eccellente flessibilità e resistenza ai raggi UV. Colore grigio. Resistente ai solventi. **Indicato per i motori fuoribordo.**

Conforme alla norma: SAEJ1527, ISO-8469 Tipo B1 e Certificazione CE. Garanzia: 3 anni

PASAMAMPAROS THRU HULL PASSA SCAFO

Ref.	R.O. OEM	Manguera Hose Tubo	Envase (x blister) Pack (x blister) Qnt (x blister)
GS31064		3/8"	1

GOLDENSHIP



Para atravesar mamparos de hasta 12mm. Fabricado en latón.

For bulkhead up to 12 mm. Made in machined brass.

Per attraversare paratie fino a 12mm. Fabbricato in ottone.

CONECTOR COMBUSTIBLE FUEL CONNECTOR ATTACCO COMBUSTIBILE

Ref.	R.O. OEM	Rosca Thread Passo	Envase (x blister) Pack (x skinpack) Qty (x Blister)
GS31034	17650-921-003ZB	3/8"	1
GS31030	17660-ZV5-902	3/8"	1
GS31032	116977-ZV5-900	1/4" NPT	1
GS31031	176060-ZV5-A00	1/4" NPT	1
	17660-ZW9-003	3/8"	1
GS31033	116977-ZV5-A00	1/4" NPT	1

GOLDENSHIP



GS31030
Modelo antiguo.
Old model.
Modello vecchio.



GS31031
Modelo nuevo
New model.
Modello nuovo.



GS31034
Modelo antiguo.
Old model.
Modello vecchio.



GS31032
Modelo antiguo.
Old model.
Modello vecchio.



GS31033
Modelo nuevo
New model.
Modello nuovo.



CONECTORES CONNECTOR ATTACCO

Ref.	Rosca Thread Passo	Envase (x blister) Pack (x skinpack) Qty (x Blister)
GS31069	1/4" NPT	1

CONECTOR "T"
Para conectar dos motores a un sólo depósito,
o viceversa. Fabricado en latón.

CONNECTOR "T"
To connect two motors to a single deposit, or
vice versa. Made in machined brass.

CONECTOR "T"
Per collegare due motori a un solo serbatoio, o
viceversa. Fabbricato in ottone.

GOLDENSHIP



Ref.	Rosca Thread Passo	Envase (x blister) Pack (x skinpack) Qty (x Blister)
GS31068	1/4" NPT	1

CODO DEPOSITO
Fabricado en latón.
TANK ELBOW
Made in machined brass.
CODO DEPOSITO
Fabbricato in ottone.

GOLDENSHIP



RACORS RACORS RACCORDO

Ref.	Rosca Thread Passo	Manguera Hose Tubo	Envase (x blister) Pack (x skinpack) Qty (x blister)
GS31065	1/4" NPT	3/8" = 9.5 mm	2
GS31166	1/4" NPT	5/16" = 7.9 mm	2
GS31155	3/8" NPT	3/8" = 9.5 mm	2
GS31156	3/8" NPT	5/16" = 7.9 mm	2
GS31157	3/8" NPT	1/4" = 6.4 mm	2

Racor 90° fabricado en latón.
Made in machined brass.
Raccordo 90° prodotto in ottone

GOLDENSHIP



Ref.	Rosca Thread Passo	Manguera Hose Tubo	Envase (x blister) Pack (x skinpack) Qty (x blister)
GS31066	1/4" NPT	5/16" = 7.9 mm	2
GS31067	1/4" NPT	3/8" = 9.5 mm	2

Fabricado en latón.
Made in machined brass.
Prodotto in ottone

GOLDENSHIP



FILTROS COMBUSTIBLE Y ELEMENTOS FUEL FILTERS AND ELEMENTS SUPPORTI, FILTRI BENZINA E RACCORDI

BRACKET BRACKET SUPPORTO

Ref.	Bracket Bracket Supporto	Tomas NTPF Ports Filetto
REC25000	Aluminio / Aluminium / Alluminio	1/4"
REC25010	INOX AISI316 / S.S. AISI316	1/4"
REC25020	Aluminio / Aluminium / Alluminio	3/8"
REC25030	INOX AISI316 / S.S. AISI316	3/8"
RECOBBRACKET	Plástico / Plastic / Plastica	1/4"

Con 2 tapones de bronce y 2 tubos de extensión.
(2 entradas y 2 salidas).
With 2 brass plugs and 2 extension tubes.
(2 inputs & 2 outputs).
Con 2 tappi di bronzo e 2 tubi di estensione.
(2 ingressi entrata carburante e 2 uscite carburante).



REC25000 - REC25020



REC25010 - REC25030



RECOBBRACKET

**FILTRO COMBUSTIBLE
SEPARADOR DE AGUA
WATER SEPARATING FUEL FILTER
FILTRO SEPARATORE ACQUA-BENZINA**

Ref.	Micras Micron Micras	Altura Height Altezza
REC855686	28	4-7/16"
REC35-802893Q	28	3-3/4"
REC24942	10	4-7/16"
REC35-802893Q01	10	3-3/4"
REC855686	28	4-7/16"
REC35-802893Q	25	3-3/4"
RACPPF5510	10	4-7/16"



REC855686



REC35-802893Q



REC24942



REC35-802893Q01



REC855686



REC35-802893Q

**FILTRO ORIGINAL
OEM FILTER
FILTRO BENZINA ORIGINALE**

Ref.	Micras Micron Micras	Altura Height Altezza
RM35-802893Q	10	3-3/4"



RM35-802893Q

**FILTRO CON BRACKET
OEM FILTER WITH BRACKET
FILTRO BENZINA CON SUPPORTO**

Ref.	Micras Micron Micras	Tomas NPTF Ports Filetto	Flujo Flow Flusso
REC24950	25	1/4"	50 GPH
REC24952	10	1/4"	50 GPH

Bracket de Aluminio. Con 2 tapones de bronce y 1 tubo de extensión.
Cast Aluminium Bracket. With 2 brass plugs & 1 extension tube.
Supporto in alluminio. Con 2 tappi di bronzo e 1 tubi di estensione.



REC24950



REC24952

Ref.	Micras Micron Micras	Tomas NPTF Ports Filetto	Flujo Flow Flusso
REC24960	28	1/4"	50 GPH
REC24956	28	1/4"	50 GPH

Bracket Inox. AISI316. Con 2 tapones de bronce y 2 tubos de extensión.
With S.S. AISI316 Bracket. With 2 brass plugs & 2 extension tubes.
Supporto Inox AISI316. Con 2 tappi di bronzo e 2 tubi di estensione.



REC24960
Bracket rojo
Red Bracket
Supporto rosso



REC24956

**FILTRO DECANTADOR COMBUSTIBLE
CON VASO TRANSPARENTE
COMPLETE FUEL FILTER WITH
TRANSPARENT BOWL
FILTRO DE DECANTAZIONE BENZINA
COMPLETO CON VASCHETTA
TRASPARENTE**

Filtro Bracket Aluminio Aluminum bracket filter Filtro con Bracket in alluminio	Filtro Bracket Plástico Plastic Bracket filter Filtro con Bracket in plastica	Elemento Element Cartuccia
RAC320R-RAC-01	RAC320R-RAC-03	RACS3213
		LENS3213



Incluye soporte
Includes bracket.
Con supporto

Filtro completo Compleat filter Filtro completo	Cartucho recambio Replacement element Cartuccia di ricambio	Capacidad Máx. Max. Capacity Capacità massima
RECOBFILTER	RECOBELEMENT	150 l/h
		LENS3213



Filtro completo Compleat filter Filtro completo	Cartucho recambio Replacement element Cartuccia di ricambio	Capacidad Máx. Max. Capacity Capacità massima
REC90794-46866	REC90794-46868	117 l/h



**LLAVE PARA FILTRO
FILTER KEY
CHIAVE DA FILTRO**

Ref.
RECYS-225-15



Filtro completo Compleat filter Filtro completo	Cartucho de recambio Replacement element Cartuccia di ricambio	Motores máximo Max. engine Motore massimo
RAC23299-10	RAC23289-10	4T 130 HP



RACOR.

Filtro de combustible con braket.
Complete fuel filter with braket.
Filtro combustibile con supporto.

Filtro completo Compleat filter Filtro completo	Micras Micron Micras	Rosca Thread Filettatura	Capacidad Máx. Max. Capacity Capacità massima
RAC490R-RAC-01	10	3/8" NPTF	340 l/h



RACOR.

CON PURGADOR. Para motores fueraborda superiores a 150 HP.
WITH PRIMING PUMP. For outboards engines more than 150 HP.
CON POMPETTA PER RIEMPIRE IL FILTRO.
Per motori fuoribordo superiori a 150 hp.

Ref.	R.O. / OEM
RACS3227	YMM-2E227-00
	YMM-2E227-01
LENS3227	

Cartucho recambio
Replacement element
Cartuccia di ricambio



RACOR.

	RAC120R-RAC-01	RAC320R-RAC-01	RAC320R-INOX-01	RAC320R-RAC-02
R.O. / OEM	99105-20006-ASY			
Flujo máximo Max. flow Flussi massimo	114 lph 30 gph	340 lph 60 gph	340 lph 60 gph	340 lph 60 gph
Elemento / Element / Elemento	RACS3240 LENS3240	RACS3213 LENS3213	RACS3213 LENS3213	RACS3220UL
R.O. Elemento / OEM Elemento	99105-20006-000			
Cazoleta transparente (1) Clear bowl (1) Vaschetta trasparente (1)	Si yes si	Si yes si	Si yes si	No
Roscas centrales Central threads Filetto centrale	M18 x 1.5	1 - 14	1 - 14	1 - 14
Tamaño rosca cabeza Head port size Dimensione vite testa	1/4-18 NPTF	1/4-18 NPTF	1/4-18 NPTF	1/4-18 NPTF
Altura x Ancho x Prof. Height x Width x Depth Altezza x Largh x Prof.	166 x 81 x 81 mm	238 x 102 x 102 mm	238 x 102 x 102 mm	238 x 102 x 102 mm
Peso / Weight / Peso	0.5 Kg	0.9 Kg	0.9 Kg	0.9 Kg
Caída de presión Pressure drop Caduta di pressione	0.15 PSI 0.01 bar	0.61 PSI 0.04 bar	0.61 PSI 0.04 bar	0.61 PSI 0.04 bar
Presión máxima (2) Max. pressure (3) Pressione massima (2)	7 PSI 0.5 bar	7 PSI 0.5 bar	7 PSI 0.5 bar	7 PSI 0.5 bar
Desmontaje cartucho-cazoleta Element removal underbowl Rimozione della cartuccia	25.4 mm 1"	25.4 mm 1"	25.4 mm 1"	25.4 mm 1"
Temp. trabajo Operating temp. Tempo lavoro	-40° C + 124° C / -40° F + 255° F			

(1) Las cazoletas transparentes sólo se recomienda para fueraborda.
Clear bowls are recommended just for outboards.
Si raccomanda l'utilizzo della vaschetta trasparente solo nei fuoribordo.

(2) Instalaciones de presión aplicables hasta el parametro escrito.
Pressure installations are applicable up to the maximum PSI shown.
L'installazione di pressione è applicabile fino al parametro scritto.

HONDA

**RECAMBIOS
MARINOS S.L.**

FILTRO COMBUSTIBLE FUEL FILTER FILTRO COMBUSTIBILE

Ref.	Capacidad Capacity Capacità	Manguera Hose Tubo	Envase (x blister) Pack (x skinpack) Qnt (x blister)
GS31001	50 lt/h	6-8 mm	1 x skinpack
GS31002	150 lt/h	8-10 mm	1 x skinpack

Filtro transparente para gasolina o gasoil.
Transparent plastic in line filter for petrol and diesel.

Filtro trasparente per benzina o diesel

GOLDENSHIP



GOLDENSHIP

Ref.	Manguera Hose Tubo	Envase (x blister) Pack (x skinpack) Qnt (x blister)
GS30435	6, 8, 10 mm	1

FILTRO TRANSPARENTE

De metal y cristal. Racors para mangueras de 6-8-10 mm.

TRANSPARENT FILTER

Clear body permits visual inspection. Racors 6-8-10 mm.

FILTRO TRASPARENTE

Di metallo e vetro. Montaggio in linea. Raccordi per tubo da 6-8-10 mm.



Ref.	Ø Manguera / Ø Hose / Ø Tubo
REC40145	1/4"
REC40155	5/16"
REC40165	3/8"
REC40135	5/16" Entrada In Entrata 3/8" Salida Out Uscita

De plástico / Plastic / In plastica

Ref.	R.O.
REC16911-ZY3-010	16911-ZY3-010

MOTORES / ENGINES / MOTORI

BF80A	BF225 AK2 / AK3 / AK1 / A6
BF100A	BF200AK2 / AK3 / AK1 / A6
BF90D2 / D4 / DK0	BF175 AK2 / AK3 / AK1 / A6
BF75DK2 / DK3 / DK0	BF250A
BF150 AK2 / A4	BF115D / DK1 / A2
BF135 AK2 / A4	BF130 A2

Ref.	R.O.
REC16910-ZV4-015	16910-ZV4-015

MOTORES / ENGINES / MOTORI

BF15AM/B/D3/DK2	BF75DK0/DK2/DK3
BF8C/CX/B1/B2/D1/D2/ P8B1/P8B2/DK2	BF40D/DK2 BF50D/DK2
BF9.9AH/AK/AM/B/ DK2/D1	BF90DK0/DK2/DK4 BF100A
BF25D4/DK2/A/A1/AX	BF60A/AK1
BF30D4/DK2/A/A1/AX	BF80A
BF20A/AX/D3	
BF10B1/D1/P10B1/ DH/DK2	

Ref.	R.O.
REC16900-SA5-004	16900-SA5-004

MOTORES / ENGINES / MOTORI

BF35AM	
BF40B/B2/BX/A4/A/A1/A2/AX/A3/AY	
BF45AM	
BF75A1/AT/AV/AX/A2/A3	
BF90A1/AF/AV/AX/A2/A3	
BF50A4/A/A1/A2/AX/A3/AY	

Series #14ZW00E1M

Ref.	R.O.
REC16910-GB2-005	16900-GB2-005

MOTORES / ENGINES / MOTORI

BF4.5B/BX/B2/B4/B6	BF8AX/B/BX/AH/AK/AM
BF5A1/AH/AK/AM/AX/ A2/A3/A4	BF50F BF75F
BF6B/BX/D6	BF100F



Ref.	R.O.
REC16900-SR3-004	16900-SR3-004

MOTORES / ENGINES / MOTORI

BF115A1 / A2 / A3 / AX
BF130A1 / A2 / A3 / AX

Series #14ZW50E1M



Ref.	R.O.
REC16010-ST5-993	16900-ST5-993

MOTORES / ENGINES / MOTORI

BF115
BF130 / AX / AY / A1

Series #14ZW50E1M



FILTROS ACEITE OIL FILTERS FILTRI OLIO

Ref.	R.O.
REC35-822626Q03	15400-PM3-004 15400-PFB-004 15400-PM3-405 15400-PJ7-015 15400-PJ7-005
REC15400-PLM-A01PE	15400-PH1-F03 15400-POH-305PE 15400-POH-305 15400-ZJI-004 15400-PLM-A01PE
REC5GH-13440-00	15400-PFB-007
REC15400-RBA-F01	15400-RBA-F01



GUÍA FILTROS DE ACEITE OIL FILTER GUIDE GUIDA FILTRI OLIO

MODELO MODEL MODELLO	AÑO YEAR ANNO	Ref.
BF8D	2001+	REC35-822626Q03
BFP8D	2001+	
BF9D BFP9D	2001+	
BF15D BFP15D	2003+	
BF20D	2003+	
BF25A	-1998	
BF30A	-1998	
BF35AM	-1998	
BF40A	-1998	
BF45AM	-1998	
BF50A	-1998	REC5GH-13440-00
BF25	1999+	
BF30	1999+	
BF40	1999+	
BF50	1999+	
BF75 BF90	1997+	REC15400-PLM-A01PE
BF115 BF130	1999+	
BF135 BF150	2004+	
BF200 BF225 BF250	2002+	
V-TEC150		
V-TEC175		

ÁNODOS / ANODES / ANODI

Ref.	R.O.		Peso Weight Peso
CM06411-ZV5-000	06411-ZV5-000	Cinc / Zinc / Zinco	0,36 kg
CM06411-ZV5-000A	06411-ZV5-000	Aluminio / Aluminium / Alluminio	0,14 kg

MOTORES / ENGINES / MOTORI

BF35, 40, 45, 50

150 x 35 mm



Ref.	R.O.		Peso Weight Peso
CM06411-ZW1-000	06411-ZW1-000	Cinc / Zinc / Zinco	0,83 kg
CM06411-ZW1-000A	06411-ZW1-000	Aluminio / Aluminium / Alluminio	0,33 kg

MOTORES / ENGINES / MOTORI

BF75 --> BF225 HP

220 x 50 mm



Ref.	R.O.		Peso Weight Peso
CM826134	41109-ZW1-003	Cinc / Zinc / Zinco	0,25 kg
CM826134A	12155-ZV5-000	Aluminio / Aluminium / Alluminio	0,10 kg

MOTORES / ENGINES / MOTORI

BF20-->BF250 HP



Ref.	R.O.		Peso Weight Peso
CM41109-ZW1-B00	41109-ZW1-B00	Cinc / Zinc / Zinco	0,22 kg
CM41109-ZW1-B00A		Aluminio / Aluminium / Alluminio	0,11 kg

MOTORES / ENGINES / MOTORI

BF40-->BF250 HP



Ref.	R.O.		Peso Weight Peso
CM6E0-45251-11	41106-935-812	Cinc / Zinc / Zinco	0,10 kg
CM6E0-45251-11A	12155-ZV5-000	Aluminio / Aluminium / Alluminio	0,04 kg

MOTORES / ENGINES / MOTORI

BF2-->BF250 HP



Ref.	R.O.		Peso Weight Peso
CM41106-ZW9-09000	41106ZW909000	Cinc / Zinc / Zinco	0,99 kg

MOTORES / ENGINES / MOTORI

BF8-->BF50HP



Ref.	R.O.		Peso Weight Peso
CM664-45371-01	06412-ZV5-000	Cinc / Zinc / Zinco	0,27 kg
CM664-45371-01A	064-45371-01	Aluminio / Aluminium / Alluminio	0,10 kg

MOTORES / ENGINES / MOTORI

BF20--> BF50HP



Ref.	R.O.		Peso Weight Peso
CM41107-ZV500	41107ZV500	Cinc / Zinc / Zinco	0,29 kg
CM41107-ZV500A		Aluminio / Aluminium / Alluminio	0,11 kg

MOTORES / ENGINES / MOTORI

BF20--> BF50HP



Ref.	R.O.		Peso Weight Peso
CM41107-ZW1-B01	41107ZW1-B01	Cinc / Zinc / Zinco	0,44 kg
CM41107-ZW1-B01A		Aluminio / Aluminium / Alluminio	0,20 kg

MOTORES / ENGINES / MOTORI

BF75-->BF130 HP



Ref.	R.O.		Peso Weight Peso
CM31640	411072ZW1003	Cinc / Zinc / Zinco	0,45 kg
CM31640A	06412-ZV1-000	Aluminio / Aluminium / Alluminio	0,20 kg

MOTORES / ENGINES / MOTORI

BF75, 90, 115, 130



Ref.	R.O.		Peso Weight Peso
TEN01400	41106-ZW-000	Cinc / Zinc / Zinco	0,020 kg

MOTORES / ENGINES / MOTORI

Serie 8 /25HP



Ref.	R.O.		Peso Weight Peso
TEN01401	01402CORR366JR3	Cinc / Zinc / Zinco	0,080 kg

MOTORES / ENGINES / MOTORI

Serie 8 /25HP



Ref.	R.O.		Peso Weight Peso
TEN01402	41106-ZV4-650 41106-935-812	Cinc / Zinc / Zinco	0,090 kg

MOTORES / ENGINES / MOTORI

BF2-->BF15 HP



Ref.	R.O.		Peso Weight Peso
TEN01404	06411-ZV5-000	Cinc / Zinc / Zinco	0,380 kg

MOTORES / ENGINES / MOTORI

BF35-->BF50 HP



HONDA

RECAMBIOS
MARINOS S.L.

Ref.	R.O.	Peso Weight Peso
TEN01406	06411-ZV1-000 Cinc / Zinc / Zinco	0,860 kg

MOTORES / ENGINES / MOTORI
BF75-->BF225 HP



Ref.	R.O.	Peso Weight Peso
TEN01405	41109-ZW1-003 Cinc / Zinc / Zinco	0,250 kg

MOTORES / ENGINES / MOTORI
Serie 75 - 130 HP



Ref.	R.O.	Peso Weight Peso
TEN01407	41109-ZW1-B00 Cinc / Zinc / Zinco	0,230 kg

MOTORES / ENGINES / MOTORI
BF40-->BF250 HP



Ref.	R.O.	Peso Weight Peso
TEN01403	41107-ZV5-000 Cinc / Zinc / Zinco	0,280 kg

MOTORES / ENGINES / MOTORI
BF20-->BF50 HP



Ref.	R.O.	Peso Weight Peso
TEN01410	41107-ZW1-B01ZA Cinc / Zinc / Zinco	0,550 kg

MOTORES / ENGINES / MOTORI
Serie 75 - 90 - 115 - 130 HP



Ref.	R.O.	Peso Weight Peso
TEN01411	41107-ZV1-003-ZA Cinc / Zinc / Zinco	0,480 kg

MOTORES / ENGINES / MOTORI
BF75-->BF130 HP



Ref.	R.O.	Peso Weight Peso
TEN01412	Cinc / Zinc / Zinco	0,210 kg



Ref.	R.O.	Peso Weight Peso
TEN01409	41106-ZW9-000 Cinc / Zinc / Zinco	0,050 kg

MOTORES / ENGINES / MOTORI
BF8-->BF50 HP



Ref.	R.O.	Peso Weight Peso
TEN01408	12155-ZV4-A00 Cinc / Zinc / Zinco	0,040 kg

MOTORES / ENGINES / MOTORI
BF8-->BF250 HP



Ref.	R.O.	Peso Weight Peso
TEN01408/1	12155-ZV5-000 Cinc / Zinc / Zinco	0,030 kg

MOTORES / ENGINES / MOTORI
BF20-->BF250 HP



MOTORES DE ARRANQUE STARTERS MOTORINI AVVIAMENTO

Ref.	R.O.
REC31200-ZW9-802	31200-ZW9-802

MOTORES / ENGINES / MOTORI
BF8B2/D2/P8B2/DK2/D3/D4/P803
BF9.9DK2/D3
BF10D4/DK2/B2/D2



Ref.	R.O.
REC31200-ZY6-003	31200-ZY6-003
	31200-ZY9-003
	31200-ZY9A-0031

MOTORES / ENGINES / MOTORI
BF115D/DK1
BF135A4/AK2
BF150A4/AK2
BF75DK0/DK2
BF90/DK2/DK0



Ref.	R.O.
PH130-0064	31200-ZW1-004

MOTORES / ENGINES / MOTORI

BF75A1/AT/AV/AX/A2/A3
BF90A1/AT/AV/AX/A2/A3
12V, 1.2 KW



Ref.	R.O.
PH130-0065	31200-ZW5-003

MOTORES / ENGINES / MOTORI

BF115A1/A2/A3/AX
BF130A1/A2/A3/AX
12V, 1.4 KW



Ref.	R.O.
ARC3446	31200-ZV5-013/003

MOTORES / ENGINES / MOTORI

BF35AM
BF40B/BX/A/A1/AX/AY/B2/A4/A2/A3
BF45AM/A/A1/AX
BF50A/A1/AX/AY/A4/A2/A3



Ref.	R.O.
PH130-0070	31200-ZY3-003 31200-ZY3A-0034

MOTORES / ENGINES / MOTORI

BF175A3/A6/AK1/AK2/AK3
BF200A2/A3/A6/AK1/AK2/AK3
BF250A
BF225A2/A3/A6/AK1/AK2/AK3



**MOTORES TRIM Y POWERTRIM
TRIM ENGINES AND
COMPLETE TRIM
MOTORINI TRIM E POWERTRIM**

**INSTALACIÓN ELÉCTRICA
WIRING HARNESS
ISTALLAZIONE ELETTRICA**

Ref.	R.O.
PH200-WH01	

Sustituye de 2 a 3 cables.
Converts 3-wire Tilt and Trim motors to 2-Wire design
Sustituisce da 2 a 3 cavi.



**TRIM COMPLETO
COMPLETE TRIM ASSEMBLY
MOTORINO TRIM COMPLETO**

Ref.	R.O.
REC18-6865	

MOTORES / ENGINES / MOTORI

3 RAM
115-225HP



Ref.	R.O.
PH200-T021	36120-ZV5-821

MOTORES / ENGINES / MOTORI

BF35AM
BF40B/B2/BX/A/A1/A2/AX/AY
BF45AM
BF50A/A1/A2/AX/AY



**GUÍA ARRANQUE
STARTER GUIDE
GUIDE AVVIAMENTO**

MODELO MODEL MODELLO	AÑO YEAR ANNO	MOTOR ARRANQUE STARTER MOTORINI AVVIAMENTO	TRIM	ALTERNADOR ALTERNATOR ALTERNATORE
BF8	2001+	REC31200-ZW9-802		
BF10	2001+	REC31200-ZW9-802		
BF9,9	2001+	REC31200-ZW9-802		
BF35	1995-1997	PH130-0054	PH200-T021	
BF40	1995+	PH130-0054	PH200-T021	
BF45	1995-1997	PH130-0054	PH200-T021	
BF50	1995+	PH130-0054	PH200-T021	
BF75	2007+	REC31200-ZY6-003		
BF75	1997-2006	PH130-0064		
BF90	1997-2006	PH130-0064		
BF90	2007+	REC31200-ZY6-003		
BF115	1999-2006	PH130-0065		
BF115	2007+	REC31200-ZY6-003		
BF130	1999-04	PH130-0065		
BF135	2004+	REC31200-ZY6-003		
BF150	2004+	REC31200-ZY6-003		
BF175	2002+	PH130-0070		REC31630-ZY3-003
BF200	2002+	PH130-0070		REC31630-ZY3-003
BF225	2002+	PH130-0070		REC31630-ZY3-003
BF250	2012+	PH130-0070		REC31630-ZY3-003

Ref.	R.O.	Motores / Engines / Motori
REC36120-ZY3-013	36120-ZY3-013	BF175A6 / AK1 / AK2 BF200AG / AK1 / AK2 BF225AG / AK / AK2
REC36120-ZY6-013	36120-ZY6-013	BF115D / DK1 BF135A4 / AK2 BF150A4 / AK2
REC36120-ZY9-003	36120-ZY9-003	BF75DK0 / DK2 / DK3 BF90DK0 / DK2 / DK4 BF100A, BF80A

4 Tornillos, conector redondo, incluye aro
4 bolt mount, round plug-in connector,
includes O-ring
4 viti, connettore rotondo, include anello



Ref.	R.O.
REC36120-ZW4-H12	36120-ZW4-H12

MOTORES / ENGINES / MOTORI

BF40A4 / D / DK2
BF50A4 / D / DK2

4 Tornillos, conector redondo, incluye aro
4 bolt mount, round plug-in connector,
includes O-ring
4 viti, connettore rotondo, include anello



**ALTERNADOR
ALTERNATOR
ALTERNATORE**

Ref.	R.O.
REC31630-ZY3-003	31630-ZY3-003

MOTORES / ENGINES / MOTORI

BF175A3/A2/A6/AK2/AK3
BF200A2/A3/A6/AK1/AK3
BF250A/A2/A3
BF225A2/A3/A6/AK1/AK2/AK3
Polea 6 canales
6 Groove pulley
Puleggia 6 canali



**REGULADORES
Y BOBINAS
REGULATORS & COILS
REGOLATORI E
BOBINE**

BOBINA / COIL / BOBINE

Ref.	R.O.
REC30520-PNA-007	30520-PNA-007

MOTORES / ENGINES / MOTORI

VTEC
BF135A4
BF150A4



Ref.	R.O.
REC30520-PWC-003	30520-PWC-S01

MOTORES / ENGINES / MOTORI

BF75DK0 / DK2 / DK3
BF90DK0 / DK2 / DK4
BF100A
BF80A



Ref.	R.O.
REC30580-ZV4-013	30580-ZV4-023

MOTORES / ENGINES / MOTORI

BF15AH / AK / AM / B / A1 / A2 / AX / AY /
B2 / BX / A3
BF9.9AH / AK / AM / B / AX / AY
BF8C / CX



**SENSOR ÁRBOL DE LEVAS
SENSOR CRAMSHAFT
SENSORE ALBERO**

Ref.	R.O.
REC37510-PNB-003	37510-PNB-003

MOTORES / ENGINES / MOTORI

BF115D / DK1
BF135A4 / AK2



**SENSOR DE OXÍGENO
O₂ SENSOR
SENSORE OSSIGENO**

Ref.	R.O.
REC35668-ZY6-003	35668-ZY6-003

MOTORES / ENGINES / MOTORI

BF115D / DK1
BF135A4 / AK2



Ref.	R.O.
REC35655-ZY3-013	35655-ZY3-013

MOTORES / ENGINES / MOTORI

BF175A3 / A6
BF200A2 / A3 / A6
BF225A2 / A3 / A6



Ref.	R.O.
REC35655-ZY9-003	35655-ZY9-003

MOTORES / ENGINES / MOTORI

BF75DK0 / DK2
BF90DK0 / DK2



DESCONECTORES DE SEGURIDAD CUT OFF SWITCHES CHIAVETTA DI SICUREZZA

KITS

Interruptor de encendido para todo tipo de motores fueraborda o intraborda.
Emergency and stop switch for inboard or outboards.
Interruttore di accensione per tutti i tipi di motori fuoribordo o entrobordo.

Ref.	Características / Features / Caratteristiche	Envase / Pack / Qnt
REC40970	Kit completo / Complete kit / Kit completo	1 x blister
REC40990	Cuerda tirador de recambio / Spare Corda elastica di ricambio	1 x blister
GS11290	Kit completo / Complete kit / Kit completo	1 x blister
GS11291	Cuerda tirador de recambio / Spare Corda elastica di ricambio	1 x blister
GS11292	Kit completo / Complete kit / Kit completo	1 x blister



REC40970 - REC40990

GS11290 - GS11291



GS11292

Ref.	Características / Features / Caratteristiche	Envase / Pack / Qnt
GS11294	Kit de 8 llaves de recambio para: Kit of 8 spare keys for: Kit di 8 chiavi di ricambi per: J/E, OMC, Mercury, Yamaha, Honda, Suzuki, Tohatsu.	1 x blister

GOLDENSHIP

Kit de 8 llaves de recambio para:
Kit of 8 spare keys for:

Kit di 8 chiavi di ricambi per:

J/E, OMC, Mercury, Yamaha, Honda,
Suzuki, Tohatsu.



INTERRUPTOR DE PARO STOP SWITCH INTERRUTTORE DI STOP

Ref.	Características / Features / Caratteristiche	Envase / Pack / Qnt
THKS-1	Un fueraborda / Single outboard / Un fuoribordo	1 x blister
THKS-2	Un intraborda / Single I/O / Un entrobordo	1 x blister
THKS-12	Dos fuerabordas / Dual outboard / Due fuoribordo	1 x blister
THKS-22	Dos intrabordas / Dual I/O / Due entrobordo	1 x blister
THL-4	Cuerda recambio / Spare lanyard / Corda ricambio	1 x blister

Interruptor de encendido para motores.
Aísla los circuitos en unidades dobles
para prevenir el retorno al alternador.
Emergency and stop switch. Isolates
circuits on dual units to prevent
feedback.

Interruttore di accensione per motori.
Isola i circuiti in doppie unità per
prevenire il ritorno all'alternatore.



BUJÍAS NGK SPARK NGK CANDELE NGK



Potencia HP Power HP Potenza HP	Año Year Anno	Ref NGK
BF 2B		NGKCR5HSB
BF 2D	1999+	NGKCR5HSB
BF 2/A	1984+	NGKBMR4A
BF 2B		NGKCR5HSB
BF 2.3		NGKCR5HSB
BF 4.5B		NGKBPR5ES
BF 5AK		NGKBPR5ES
BF 5	1984+	NGKBPR5ES
BF 5A		NGKBPR5ES
BF 6B	2003+	NGKDR4HS
BF 6		NGKDR4HS
BF 6CH	2004+	NGKCR5EH-9
BF 7,5	1977+	NGKDR5HS
BF 8	2001+	NGKCR5EH-9
BF 8D		NGKCR5EH-9
BF 8D1	8.0HP 2001+	NGKCR5EH-9
BF 8	1987-2000	NGKDR5HS
BF 8 A/B/C	1990-2000	NGKDR5HS
BF 8B1		NGKCR5EH-9
BF 9/A		NGKDR5HS
BF 9.9	1987-2001	NGKDR5HS
BF 9.9 A/B		NGKDR5HS
BF 9.9D1	9.9HP 2001+	NGKCR5EH-9
BF 10D	2001+	NGKCR5EH-9
BF 10/B1	2001+	NGKCR5EH-9
BF 15D	2003+	NGKCR5EH-9
BF 15B		NGKDR5HS
BF 15	1987-1990	NGKDR6HS
BF 15A	1996-2002	NGKDR5HS
BF 20	1993+	NGKDR7EA
BF 20/F	1985+	NGKBMR4A
BF 20D	2003+	NGKCR5EH-9
BF 25/A	1993+	NGKDR7EA
BF 25B		NGKDR7EA
BF 25D4	2004+	NGKDR7EA
BF 28		NGKCR5HSB
BF 28D		NGKCR5HSB
BF 30/A	1994+	NGKDR7EA
BF 30D4	2004+	NGKDR7EA
BF 35/A	1990+	NGKDR7EA
BF 40B		NGKDR7EA
BF 40/A	1994+	NGKDR7EA
BF 45/A	1990+	NGKDR7EA
BF 50/F	1985-1994	NGKBPR5ES
BF 50	1986-1994	NGKBPR5ES
BF 50/A	1994+	NGKDR7EA
BF 70A		NGKDR7EA
BF 75	2003+	NGKDR7EA
BF 75B		NGKDR7EA
BF 75E		NGKDR5HS
BF 75A	1995+	NGKDR7EA
BF 75		NGKDR5HS
BF 90/A	1995+	NGKDR7EA
BF 100E		NGKDR5HS
BF 100		NGKDR5HS
BF 115/A	1998+	NGKZFR7F
BF 130A	1998+	NGKZFR7F
BF 135A		NGKIZFR6K11
BF 150A		NGKIZFR6K11
BF 175A		NGKIZFR6K11
BF 200A V6	2002+	NGKIZFR6K11
BF 225A V6	2002+	NGKIZFR6K11
BF 250A	2010+	NGKIZFR6K11

BUJÍAS CHAMPION SPARK CHAMPION CANDELE CHAMPION



Potencia HP Power HP Potenza HP	Año Year Anno	Ref CHAMPION
2HP	BF2A,D	CHACJ14
5HP	OHC - BF5A	CHARN11YC4
7.5HP	B75	CHAP10Y
8.0HP	OHC - BF8A	CHAP10Y
9.9HP	BF9.9A	CHAP10Y
15HP	OHC - BF15A	CHAP8Y
20HP	BF20A	CHARA6HC
25HP	OHC - BF25A	CHARA8HC
30HP	OHC - BF30A	CHARA8HC
35HP	BF35A	CHARA8HC
40HP	OHC - BF40A	CHARA8HC
45HP	BF45A	CHARA8HC
50HP	OHC - BF50A	CHARA8HC
70HP	OHC - BF70A	CHARA8HC
75HP	BF75A	CHARA8HC
90HP	OHC - BF90A	CHARA8HC
115HP	OHC	CHARC9MC4
130HP	OHC	CHARC9MC4
150HP	BF150, BF200, 225	CHARC9MC4

JUNTA DE CULATA GASKET CYLINDER HEAD GUARNIZIONE TESTATA

JUNTA DE CULATA GASKET CYLINDER HEAD GUARNIZIONE TESTATA

Ref. R.O.
REC12251-ZV7-004 12251-ZV7-004

MOTORES / ENGINES / MOTORI

BF20A / A2 / AX
BF25A / A1 / 2 / A3 / AX
BF30A / A1 / A2 / A3 / AX

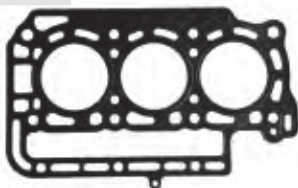

Ref. R.O.
REC12251-ZV5-003 12251-ZW4-H01

MOTORES / ENGINES / MOTORI

BF35
BF40A2 / A3 / A4 / B2 / D / D2
BF50A2 / A3 / A4 / D / DK2

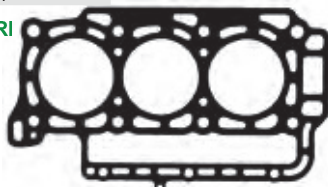

Ref. R.O.
REC12251-ZW1-014 12251-ZW1-014

MOTORES / ENGINES / MOTORI

BF75A1 / A2 / A3 / AT / AX / AV
BF90A1 / A2 / A3 / AT / AX / AV



Ref. R.O.
REC12251-ZW5-023 12251-ZW5-023

MOTORES / ENGINES / MOTORI

BF115A2 / A3
BF130A2 / A3

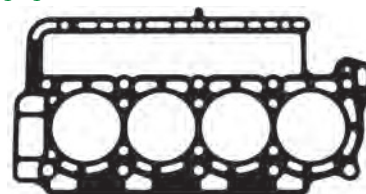

JUNTAS BASE MOTOR GASKET, ENGINE HOLDER GUARNIZIONE, BASE MOTORE

Ref. R.O.
REC23172-ZW1-013 23172-ZW1-013

MOTORES / ENGINES / MOTORI

BF75A1 / A2 / A3
BF90A1 / A2 / A3

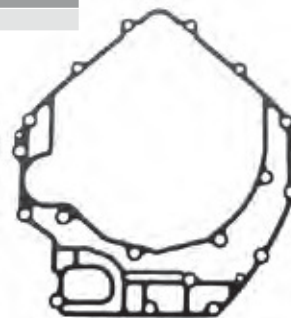

Ref. R.O.
REC23172-ZW5-013 23172-ZW5-013

MOTORES / ENGINES / MOTORI

BF115A1 / A2 / A3 / AX
BF130A1 / A2 / A3 / AX

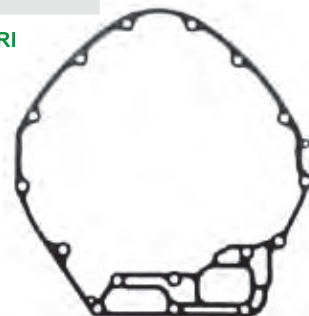

JUNTAS BOMBA ACEITE GASKET OIL PUMP GUARNIZIONE POMPA OLIO

Ref. R.O.
REC15112-ZW5-003 15112-ZW5-003

MOTORES / ENGINES / MOTORI

BF115A1 / A2 / A3 / AX
BF130A1 / A2 / A3 / AX

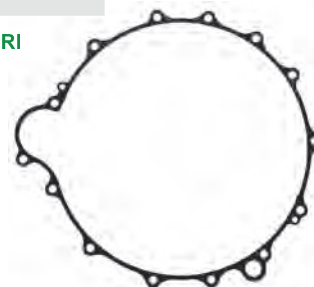

JUNTA SILENCIOSO GASKET MUFFLER GUARNIZIONE SILENZIATORE

Ref. R.O.
REC17384-ZW4-000 17384-ZW4-000

MOTORES / ENGINES / MOTORI

BF25D4 / DK2 / A4
BF30D4 / DK2 / A4



KIT JUNTAS GASKET KIT KIT GUARNIZIONE

Ref. R.O.
RM061A1-ZV0-000 061A1-ZV0-000

MOTORES / ENGINES / MOTORI
BF20F



Ref. R.O.
RM061A1-ZV7-000 061A1-ZV7-000

MOTORES / ENGINES / MOTORI
BF20A
BF25A



Ref. R.O.
RM06111-ZW1-020 06111-ZW1-000

MOTORES / ENGINES / MOTORI
BF75A1 / AT / AV / AX
BF90 / A1 / AT / AV / AX



CORREAS DISTRIBUCIÓN TIMMING BELTS CINGHIE DISTRIBUZIONE

Ref. R.O.
RM14400-921-024 14400-921-024

MOTORES / ENGINES / MOTORI
F8AX / B / BX / AH / AK / AM
BF6BX / D6
BF75A / B / C / D / K2 / K3 / E / F
BF100A / B / C / D / E / F



Ref. R.O.
RM14400-ZV4-004 14400-ZV4-004

MOTORES / ENGINES / MOTORI
BF8C / CX
BF9.9AH / AK / AM / B / AX / BX / AY
BF15AH / AK / AM / B / A1 / A2 / AX / B2 / A3 / AY



Ref. R.O.
RM14400-ZV5-004 14400-ZV5-004

MOTORES / ENGINES / MOTORI
BF35AM
BF40B / B2 / BX / A / A1 / A2 / AX / AY
BF45AM
BF50A / A1 / A2 / AX / AY



Ref. R.O.
RM14400-ZW1-004 14400-ZW1-004

MOTORES / ENGINES / MOTORI
BF75A1 / AT / AV / AX / A2 / A3
BF90A1 / AT / AV / AX / A2 / A3



RETÉN DE VÁLVULAS VALVE SEALS TENUTE

ESCAPE / EXHAUST / SCARICO

Ref. R.O.
REC12209-MB9-003 12209-MB9-003

MOTORES / ENGINES / MOTORI
BF75A1 / AT / AV / AC / A2 / A3
BF90A1 / AT / AV / AX / A2 / A3



ADMISIÓN Y ESCAPE INTAKE & EXHAUST ASPIRAZIONE E SCARICO

Ref. R.O.
REC12209-6B4-681 12209-GB4-681

MOTORES / ENGINES / MOTORI
BF8B1 / B2 / D1 / D2 / DK2 / D3 / D4
BF9.9DK2 / D1 / D2 / D3
BF10B1 / D1 / D4 / DK2 / D2



TERMOSTATO THERMOSTAT TERMOSTATO

Ref. R.O.
REC19300-881-741 19300-881-741 62°C

MOTORES / ENGINES / MOTORI
BF6D6
BF100F
BF75F
BF8AH / AK / AM



Ref. R.O.
REC19300-881-761 19300-881-761 52°C

MOTORES / ENGINES / MOTORI
BF4.5B / BX / BK2 / BF8AX / B / BX / C /
B2 / B4 / B6 / BK0 CX / AH / AK / AM
BF5AH / AK / AM / AX BF100F
/AK2 / A2 / A3 / A4 BF75F
BF15AH / AK / AM / B / BF9.9AH / AK / AM / B
A1 / A2 / A3 / AX / AY / AX / BX / AY
B2 / BX
F6B / BX



Ref.	R.O.
PAF15-07000031	19300-ZW9-003 60°C

MOTORES / ENGINES / MOTORI

BF25D4 / DK2 BF15D3 / DK2
 BF30D4 / DK2 BF20D3
 BF40A / D / DK2 / E BF200A
 BF50A / D / DK2 BF225A
 BF8B1 / B2 / D1 / D2 / DK2 / D3 / D4 BF75DK0 / DK2 / DK3
 BF9.9DK2 / D1 / D2 BF90DK0 / DK2 / DK4
 / D3 BF100A
 BF10B1 / B1 / D4 / BF80A
 DK2 / B2 / D2 BF60A / AK1



Ref.	R.O.
REC19300-ZV5-043	19300-ZV5-043 72°C

MOTORES / ENGINES / MOTORI

BF35AM BF90A1 / AT / AV / AX
 BF40B / B2 / BX / AX / / A2 / A3
 A1 / A2 / A3 / AY BF115A1 / A2 / AX
 BF45AM BF130A1 / A2 / AX
 BF20AX / A BF50A2 / AX / A1 /
 BF25A / A1 / AX A3 / AY
 BF30A / A1 / AX / A2 BF20A2 / A3
 / A3 BF25A1 / A2 / A3
 BF75A1 / AT / AV / AX
 / A2 / A3



**CARBURADOR
 CARBURETOR
 CARBURATORI**

**KITS CARBURADOR
 CARBURETOR KIT
 KIT CARBURATORI**

Ref.	R.O.
REC06160-ZV4-U11	06160-ZV4-U11 Honda KIT1

MOTORES / ENGINES / MOTORI

BF9.9 / BF15 (-2008)



Ref.	R.O.
REC16010-ZV4-005	16010-ZV4-005 Honda KIT3

MOTORES / ENGINES / MOTORI

BF75 (1997+)
 BF90 (1997+)



Ref.	R.O.
REC16010-ZW9-003	16010-ZW9-003 Honda KIT2

MOTORES / ENGINES / MOTORI

BF9.9 (2001+)
 BF15 (2003+)



Ref.	R.O.
REC18-7053	Honda KIT4

MOTORES / ENGINES / MOTORI

BF8 (2001+) BF35 (1997)
 BF9.9 BF40
 BF15 BF45 (1997)
 BF20 (2003+) BF50
 BF25 BF75 (1997+)
 BF30 BF90 (1997+)



**AGUJA CARBURADOR
 NEEDLE VALVE
 SPILLO CONICO CARBURATORE**

Ref.	R.O.
REC16011-881-741	16011-881-741

MOTORES / ENGINES / MOTORI

BF5 (-2003)
 BF8
 BF75 (-1997)
 BF100 (-1997)



Ref.	R.O.
REC16011-ZV4-005	16011-ZV4-005

MOTORES / ENGINES / MOTORI

BF8 (2001+) BF35 (1997)
 BF9.9 BF40
 BF15 BF45 (1997)
 BF20 (2003+) BF50
 BF25 BF75 (1997+)
 BF30 BF90 (1997+)



**JUNTAS ADMISIÓN
 ADMISION GASKET
 GUARNIZIONE ASPIRAZIONE**

Ref.	R.O.
REC16221-ZW9-000	16221-ZW9-000

MOTORES / ENGINES / MOTORI

BF8B1 / B2 / D1 / D2 / DK2 / D3 / D4
 BF9.9DK2 / D1 / D2 / D3
 BF10B1 / D1 / D4 / DK2 / B2 / D2



Ref.	R.O.
REC16201-881-850	16201-881-850

MOTORES / ENGINES / MOTORI

BF6B / BX / D6
 BF8AX / B / BX / AK / AM



Ref.	R.O.
REC16221-ZV4-610	16221-ZV4-610

MOTORES / ENGINES / MOTORI

BF15AK / AM / B / A1 / A2 / AX / B2 / BX / A3 / A4
 BF9.9AK / AM / B / AX / BX / AY
 BF8C / CX



Ref.	R.O.
REC16221-ZW1-000	16221-ZW1-000

MOTORES / ENGINES / MOTORI

BF75A1 / AT / AV / AX / A2 / A3
BF90A1 / AT / AV / AX / A2 / A3



Ref.	R.O.
REC17109-ZY3-004	17109-ZY3-004

MOTORES / ENGINES / MOTORI

BF250A
BF175A3 / A6 / AK1 / AK2 / AK3
BF200A2 / A3 / A6 / AK1 / AK2 / AK3
BF225A2 / A3 / A6 / AK1 / AK2 / AK3

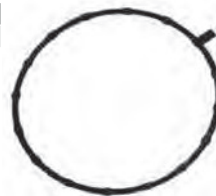

Ref.	R.O.
REC17109-ZY6-000	17109-ZY6-000

MOTORES / ENGINES / MOTORI

BF115D / DK1
BF135A4 / AK2
BF150A4 / AK2
BF75DK0 / DK2 / DK3
BF90DK0 / DK2 / DK4
BF100A
BF80A



Ref.	R.O.
REC17151-ZW5-000	17151-ZW5-000

MOTORES / ENGINES / MOTORI

BF115A1 / A2 / A3 / AX
BF130A1 / A2 / A3 / AX



Ref.	R.O.
REC17105-ZY6-000	17105-ZY6-000

MOTORES / ENGINES / MOTORI

BF115D / DK1
BF135A4 / AK2
BF150A4 / AK2



Ref.	R.O.
REC17105-ZY3-004	17105-ZY3-004

MOTORES / ENGINES / MOTORI

BF250A
BF175A3 / A6 / AK1 / AK2 / AK3
BF200A2 / A3 / A6 / AK1 / AK2 / AK3
BF225A2 / A3 / A6 / AK1 / AK2 / AK3

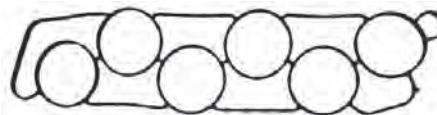

GUÍA IMPULSORES / IMPELLER GUIDE / GUIDA GIRANTE

MEDIDAS mm (A-B-C)
Measurements mm (A-B-C)
Misure mm (A-B-C)

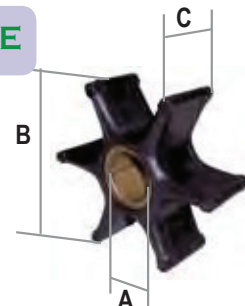

Modelo Model Modello	AÑO YEAR ANNO	R.O. OEM	Ref. RECMAR	Ref. CEF	Medidas / Measurements / Misure		
					A	B	C
BF2AH-AK-AM/BF20F		19211-ZV0-003	RM19211-ZV0-003	N/A	10,50	40,00	22,50
BF4.5B		19210-881-A02	REC19210-881-003	CEF500327	14,20	41,00	23,00
BF50F/BF5		19210-881-A02	REC19210-881-003	CEF500327	14,20	41,00	23,00
BF6B-BX-D6		19210-881-A02	REC19210-881-003	CEF500327	14,20	41,00	23,00
BF75(7.5HP) A-B-C-D-E-F		19210-881-A02	REC19210-881-003	CEF500327	14,20	41,00	23,00
BF8B-D/BF9.9D/BF10 B-D Power trust(2000)		19210-ZW9-003	REC19210-ZW9-013	CEF500347	13,00	45,60	14,80
BF8B-D/BF9.9D/BF10 B-D (2000)		19210-ZW9-A31	REC19210-ZW9-A32	CEF500348	16,20	45,60	14,80
BF8AH-AK-AM-AX-B-BX		19210-881-A02	REC19210-881-003	CEF500327	14,20	41,00	23,00
BF8C-CX		19210-ZV4-651	REC19210-ZV4-651	CEF500343	14,10	41,00	27,55
BF9.9/BF15AH-AK-AM-H-K-M		19210-ZV4-013	REC19210-ZV4-013	CEF500328	14,20	41,00	27,55
BF9.9/BF15AM-AY-AX-A1-A4-B-BX-B2-M		19210-ZV4-651	REC19210-ZV4-651	CEF500343	14,10	41,00	27,55
BF100(10HP)A-B-C-D-E-F		19210-881-A02	REC19210-881-003	CEF500327	14,20	41,00	23,00
BF15/BF20D3-DK2		19210-ZW9-A31	REC19210-ZW9-A32	CEF500348	16,20	45,60	14,80
BF20/BF25/BF30A-AX-A1-A2-A3-A4-D4-DK2		19210-ZV7-003	REC19210-ZV7-003	CEF500339	17,20	55,75	20,20
BF35/BF45AM		19210-ZV5-003	REC19210-ZV5-003	CEF500338	17,20	55,90	20,20
BF40A-AX-AY-B-BX-E-D-DK		19210-ZV5-003	REC19210-ZV5-003	CEF500338	17,20	55,90	20,20
BF50/BF60A-AX-AK-AY-D-DK		19210-ZV5-003	REC19210-ZV5-003	CEF500338	17,20	55,90	20,20
BF75/BF90AT		19210-ZW1-303	REC47-43026Q02	CEF500301	22,40	89,00	32,50
BF75/BF90AV-AX	1999+	19210-ZW1-B04	REC19210-ZW1-B02	CEF500337	23,35	87,80	31,00
BF115/BF130	1999+	19210-ZW1-B04	REC19210-ZW1-B02	CEF500337	23,35	87,80	31,00
BF135/BF150	2004+	19210-ZW1-B04	REC19210-ZW1-B02	CEF500337	23,35	87,80	31,00
BF175/BF200/BF225		19210-ZY3-003	REC19210-ZY3-003	CEF500391	26,00	89,75	31,30

DESPIECE COLA GEARCASE COMPONENTS ESPLOSO PIEDE

RECMAR[®]

BF75AT / BF90AT

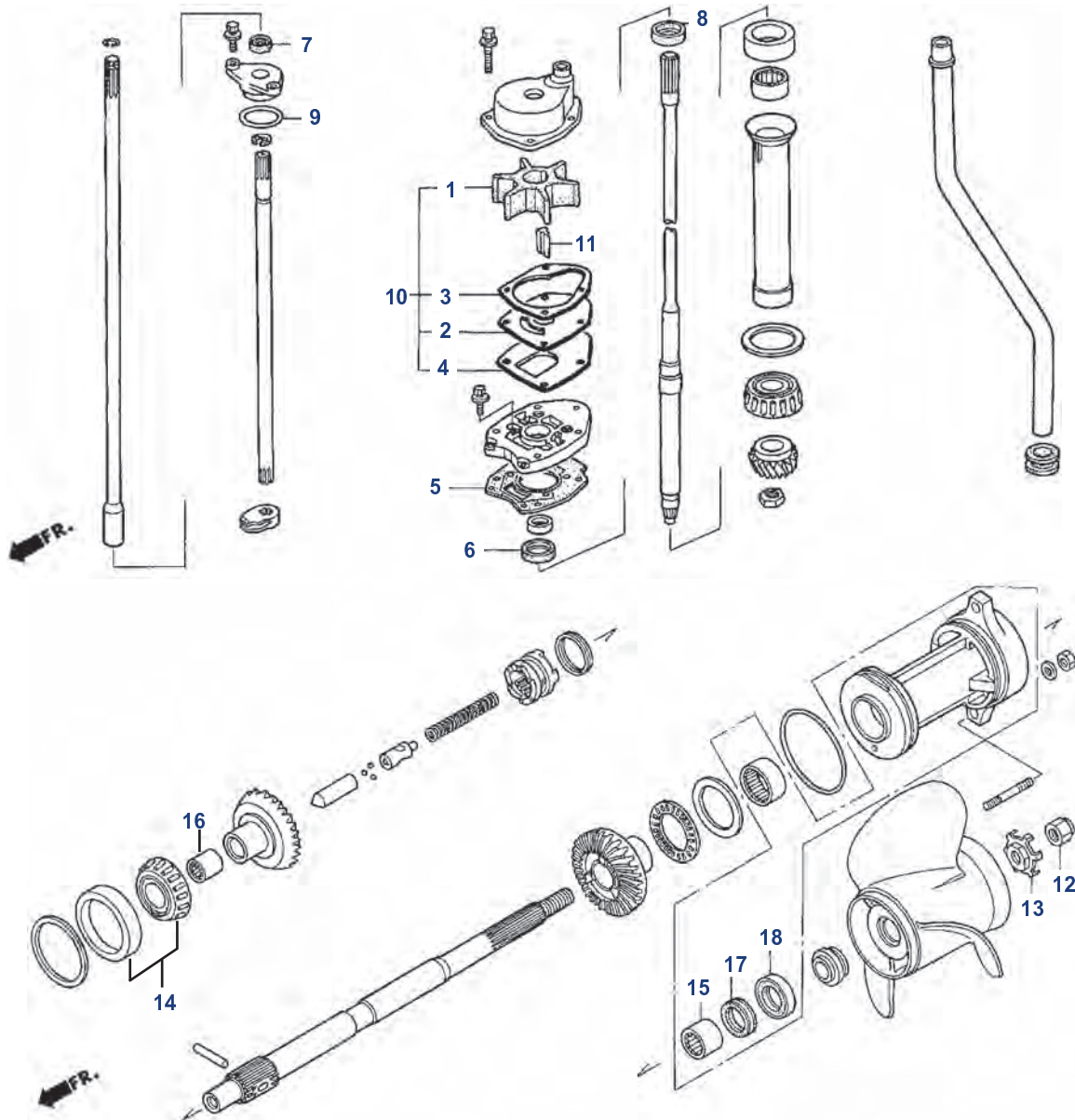

Nº	Ref.	R.O.	OEM	Descripción	Description	Descrizione
1	REC47-43026Q02	19120-ZW1-303		IMPULSOR	IMPELLER	GIRANTE
2	REC8172761	19231-ZW1-003		BASE INOX	OUTER PLATE	PIASTRA INOX
3	REC27-8172771	19232-ZW1-003		JUNTA	GASKET	GUARNIZIONE
4	REC27-430331	19234-ZW1-003		JUNTA	GASKET	GUARNIZIONE
5	REC27-430472	19242-ZW1-003		JUNTA	GASKET	GUARNIZIONE
6	REC26-43035	91251-ZW1-003		RETEN	OIL SEAL	PARAOLIO
7	REC26-8164641	91253-ZW1-003		RETEN	OIL SEAL	PARAOLIO
8	REC26-43036	91254-ZW1-003		RETEN	OIL SEAL	PARAOLIO
9	REC91353-ZW1-003	91353-ZW1-003		TORICA	O-RING	ANELLO
10	REC47-43026Q06	19021-ZW1-003		KIT BOMBA AGUA	WATER PUMP KIT	KIT POMPA ACQUA
11	REC90752-ZW1-B02	90752-ZW1-003		CHAVETA	KEY	CHIAVETTA
12	REC90301-ZW1-003	90301-ZW1-003		TUERCA HELICE	NUT PROPELLER	DADO ELICHE
13	REC90508-ZW1-003	90508-ZW1-003		ARANDELA SEGURIDAD	WASHER TAB	RONDELLA
14	REC31-30894A1	91051-ZW1-003		RODAMIENTO AVAN.	BEARING FORWARD	CUSCINETTO AVANTI
15	REC387247	91053-ZW1-003		RODAMIENTO AGUJAS	NEEDLE BEARING	CUSCINETTO ASSE
16	REC31-30895T	91057-ZW1-003		RODAMIENTO RODILLOS	ROLLER BEARING	CUSCINETTO PIGNONE
17	REC26-76868	91252-ZW1-003		RETEN	SEAL,WATER	TENUTA
18	REC26-70081	91351-ZW1-003		RETEN	SEAL,WATER	TENUTA

COLAS LOWER UNIT PIEDI

KITS REPARACIÓN BOMBA AGUA WATER PUMP SERVICE KITS KIT RICAMBI POMPE ACQUA

Ref. R.O.
REC06192-ZV1-C00 06192-ZV1-C00

MOTORES / ENGINES / MOTORI
BF4.5B / BK2 / BK0
BF5A1 / AM / AX / AAK2 / A2 / A3 / A4



Ref. R.O.
REC06192-881-C00 06192-881-C00

MOTORES / ENGINES / MOTORI
BF6B / BX / D6
BF8AX / B / BX / AM



Ref. R.O.
REC06192-ZV4-000 06192-ZV4-000

MOTORES / ENGINES / MOTORI
BF8C / CX
BF15A2 / A3 / B2



Ref. R.O.
REC06192-ZV7-000 06192-ZV7-000

MOTORES / ENGINES / MOTORI
BF25D4 / DK2 / A2 / A3
BF30D4 / DK2 / A2 / A3
BF20A2



Ref. R.O.
REC06192-ZV5-003 06192-ZV5-003

MOTORES / ENGINES / MOTORI
BF35AM
BF40B / B2 / BX / A4 / D / DK2 / A / A1 / A2 / AX / A3
BF45AM
BF50A4 / D / DK2 / A / A21 / A2 / AX / A3



Ref. R.O.
REC47-43026Q06 19021-ZW1-003

MOTORES / ENGINES / MOTORI
BF75AT
BF90AT



Ref. R.O.
REC06192-ZV1-305 06192-ZV1-305

MOTORES / ENGINES / MOTORI
BF75AT
BF90AT



Ref. R.O.
REC06192-ZV1-000 06192-ZW1-000

MOTORES / ENGINES / MOTORI
BF115A2 / A3
BF130A2 / A3
BF75DK0 / DK1 / A2 / A3
BF90 DK0 / DK1 / A2 / A3

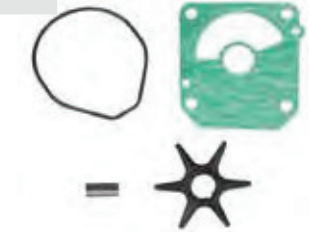

Ref. R.O.
REC06192-ZY6-000 06192-ZY6-000

MOTORES / ENGINES / MOTORI
BF115D / DK1
BF135A4 / AK2
BF150A4 / AK2



Ref. R.O.
REC06192-ZY3-000 06192-ZY3-000

MOTORES / ENGINES / MOTORI
BF175A3 / A6 / AK1 / AK2 / AK3
BF200A2 / A3 / A6 / AK1 / AK2 / AK3
BF225A2 / A3 / A6 / AK1 / AK2 / AK3

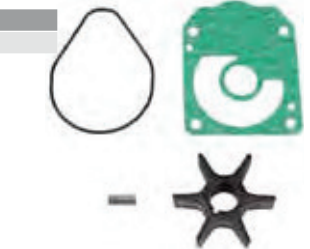

KITS REPARACIÓN COLA LOWER UNIT SEAL KITS KIT RICAMBI PIEDE

Modelo / Model / Modello	Ref.
BF9.9	REC18-8363
BF15	REC18-8362-1
BF35/45 AM	REC18-8362-1
BF40/50 A, AW, AX	REC18-8362-1
BF75	REC18-8366
BF90	REC18-8365
BF115	REC18-8365
BF130	REC18-8365

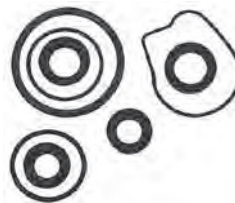

REC18-8362-1
Series 14ZV50M



REC18-8363

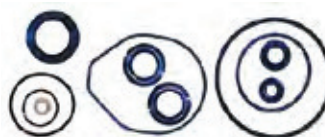

REC18-8365

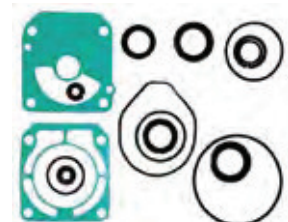

REC18-8366

CHAVETA / KEY / CIAVETTA

Ref.	R.O.
REC90752-ZV4-650	90752-ZV4-650

MOTORES / ENGINES / MOTORI

BF8C / CX
BF9.9AM / B / AX / BX / AY
BF15AM / B / A1 / A2 / AX / B2 / BX / A3 / AY



Ref.	R.O.
REC90752-ZV7-000	90752-ZV7-000

MOTORES / ENGINES / MOTORI

BF25D4 / DK2 / A / A1 / AX / A2 / A3
BF30D4 / DK2 / A / A1 / AX / A2 / A3
BF20A / AX / A2



Ref.	R.O.
REC90752-ZW1-B02	90752-ZW1-B02

MOTORES / ENGINES / MOTORI

BF80A / BF100A
BF150A4 / AK2
BF75A1 / AV / AX / DK2 / DK3 / A2 / A3
BF90A1 / AV / AX / DK0 / DK2 / DK4 / A2 / A3
BF115A1 / A2 / A3 / AX / D / DK1
BF130A1 / A2 / A3 / AX
BF135A4 / AK2



Ref.	R.O.
REC90752-ZV5-003	90752-ZV5-003

MOTORES / ENGINES / MOTORI

BF60A / AK1
BF50A4 / D / DK2 / A / A1 / A2 / AX / A3 / AY
BF35AM
BF40B / B2 / BX / D / DK2 / A / A1 / A2 / AX / E / A3 / AY / A4
BF45AM



Ref.	R.O.
REC90752-ZY3-003	90752-ZY3-003

MOTORES / ENGINES / MOTORI

BF225A2 / A3 / A6 / AK2 / AK3
BF175A3 / A6 / AK1 / AK2 / AK3
BF200A2 / A3 / A6 / AK1 / AK2 / AK3
BF250A / AK1



RETEN CUERPO BOMBA SEAL WATER PUMP TENUTE CORPO POMPA

Ref.	R.O.
REC91252-ZV1-003	91252-ZV1-003

MOTORES / ENGINES / MOTORI

B4.5B / BX / BK2 / B4 / B6
BF5A1 / H / AK / AM / AX / AK2 / A2 / A3 / A4
BF8B1 / D1 / D2 / B2 / DK2 / D3 / D4
BF9.9DK2 / D1 / D2 / D3
BF10B1 / D1 / D4 / DK2 / B2 / D2
BF50F



Ref.	R.O.
REC91252-935-004	91252-935-004

MOTORES / ENGINES / MOTORI

BF9.9A
BF15A
BF100A / B / C / D / E / F
BF75A / B / C / D / K2 / K3 / E / F
BF15AH / AK / AM / B / A1 / A2 / AX / B2 / BX / A3 / AY
BF9.9AH / AK / AM / B / AX / BX / AY
BF6BX / D6
BF8AX / B / BX / C / CX / AH / AK / AM



JUNTA TAPÓN DRENAJE DRAIN SCREW GASKET GUARNIZIONE SCARICO

Ref.	R.O.
REC12-191833	12-191833



RETEN COLA SEAL GEARCASE TENUTE PIEDE

REF	R.O. / OEM	
REC26-43036	91254-ZW1-003	Eje transmisión Drive Shaft Asse di trasmissione
REC26-43035	91251-ZW1-003	Eje transmisión Drive Shaft Asse di trasmissione
REC26-76868	91252-ZW1-003	Eje hélice Prop Shaft Asse eliche
REC26-70081	91255-ZW1-003	Eje hélice Prop Shaft Asse eliche
REC26-8164641	91253-ZW1-003	Eje de cambio Shift Shaft Asse di cambio

MOTORES / ENGINES / MOTORI

BF75AT
BF90AT



REC26-43036



REC26-43035



REC26-76868



REC26-70081



REC26-816464 1

JUNTA EJE SELECTOR O-RING DRIVE SHAFT GUARNIZIONE ASSE TRASMISSIONE

Ref.	R.O.
REC25-457101	91353-ZW1-003

MOTORES / ENGINES / MOTORI

DF75AT
DF90AT



JUNTA BOMBA AGUA WATER PUMP GASKET GUARNIZIONE POMPA ACQUA

Ref.	R.O.
REC8172761	19231-ZW1-003

MOTORES / ENGINES / MOTORI

BF75A
BF90A



Ref.	R.O.
REC19232-ZV1-A10	19232-ZV1-A10

MOTORES / ENGINES / MOTORI

BF4.5B / BX / BK2 / B2 / B4 / B6 / BK0
BF5A1 / AM / AX / AK2 / A2 / A3 / A4



Ref.	R.O.
REC19232-881-850	19232-881-850

MOTORES / ENGINES / MOTORI

BF6B / BX / D6
BF8AX / B / BX / AK / AM



Ref.	R.O.
REC19234-881-850	19234-881-850

MOTORES / ENGINES / MOTORI

BF6B / BX / D6
BF8AX / B / BX / AK / AM



Ref.	R.O.
REC19232-ZV4-610	19232-ZV4-610

MOTORES / ENGINES / MOTORI

BF15AK / AM / B / A1 / A2 / AX / B2 / BX / A1 / A2 / A3 / AY
BF9.9AK / AM / B / AX / BX / AY
BF8C / CX



Ref.	R.O.
REC19233-ZV5-000	19233-ZV5-000

MOTORES / ENGINES / MOTORI

BF35AM
BF40B / B2 / BX / A4 / D / DK2 / A / A1 / 2 / AX / AY
BF45AM
BF25D4 / DK2 / A / A1 / AX / A2 / A3
BF30D4 / K2 / A / A1 / AX / AZ / A3
BF50A4 / D / DK2 / A / A1 / A2 / AX



Ref.	R.O.
REC27-8172771	19232-ZW1-003

MOTORES / ENGINES / MOTORI

BF75A
BF90A



Ref.	R.O.
REC27-430331	19234-ZW1-003

MOTORES / ENGINES / MOTORI

BF75A
BF90A



Ref.	R.O.
REC27-430472	19242-ZW1-003

MOTORES / ENGINES / MOTORI

BF75A
BF90A



Ref.	R.O.
REC19234-ZY3-000	19234-ZY3-000

MOTORES / ENGINES / MOTORI

BF175A3 / A6 / AK1 / AK2 / AK3
BF200A2 / A3 / A6 / AK1 / AK2 / AK3
BF225A2 / A3 / A6 / AK1 / AK2 / AK3



Ref.	R.O.
REC19242-ZV5-000	19242-ZV5-000

MOTORES / ENGINES / MOTORI

BF20A / AX / A2
BF35AM
BF40B / B2 / BX / A4 / D / DK2 / A / A1 / A2 / AX / A3 / AY
BF45AM
BF25D4 / DK2 / A / A1 / AX / A2 / A3
BF50A4 / D / DK2 / A / A1 / A2 / A3 / AY
BF30D4 / DK2 / A / A1 / AX / A2 / A3

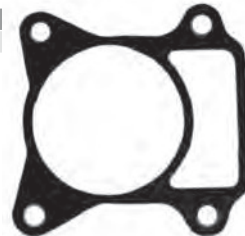

COMPONENTES TRANSMISIÓN GEAR COMPONENTS COMPONENTI TRASMISSIONE

**TUERCA DIÁBOLO
NUT, GEARCASE END
DADO DIAVOLO**

Ref.	R.O.
REC41109-ZV5-000	41109-ZV5-000

MOTORES / ENGINES / MOTORI

BF35AM
BF40B / B2 / BX / A4 / A / A1 / A2 / AX / A3 / AY
BF45AM
BF50A4 / A / A1 / A2 / AX / A3 / AY



**EJE HÉLICE
PROPELLER SHAFT
ASSE ELICHE**

Ref.	R.O.
REC41161-ZV5-000	41161-ZV5-000

MOTORES / ENGINES / MOTORI

BF35AM
BF40B / B2 / BX / A4 / A / A1 / A2 / AX / A3 / AY
BF45AM
BF50A4 / A / A1 / A2 / AX / A3 / AY



**RODAMIENTO PIÑÓN AVANTE
FORWARD GEAR BEARING
CUSCINETTO PIGNONE AVANTI**

Ref.	R.O.
REC31-30894A1	91051-ZW1-003
REC31-30895T	91057-ZW1-003

MOTORES / ENGINES / MOTORI

BF75AT
BT90AT



REC31-30894A1



REC31-30895T

**RODAMIENTO DIÁBOLO
CARRIER BEARING
CUSCINETTO DIAVOLO**

Ref.	R.O.
REC387247	91053-ZW1-003

MOTORES / ENGINES / MOTORI

BF75AT
BF90AT



**ARANDELA CIERRE
TAB WASHER
RONDELLA CHIUSURA**

MOTORES / ENGINES / MOTORI

BF75AT
BR90AT



HÉLICES ALUMINO E INOXIDABLES DE 3 Y 4 PALAS 3 & 4 BLADE ALUMINUM & STAINLESS STEEL PROPELLERS ELICHE ALLUMINIO E INOX DA 3 E 4 PALE

SISTEMA CODIGO REFERENCIAS
PART NO. CODING SYSTEM
SISTEMA DI CODICE

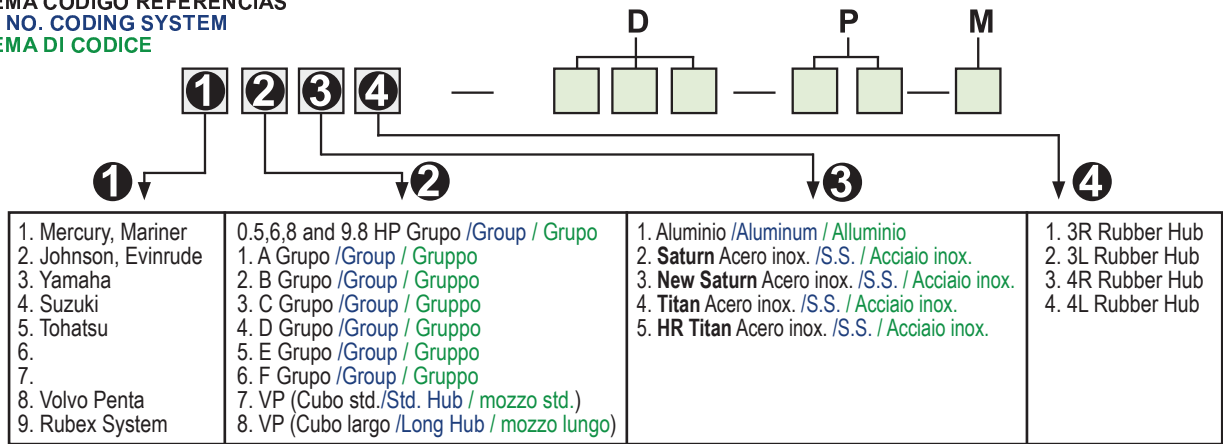

Ejemplo
Note
Esempio

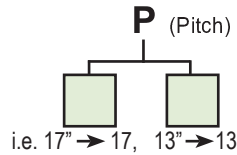
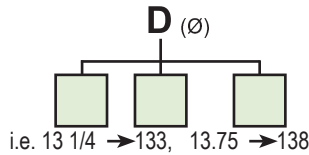

SOLAS AMITA 3

- Hélices de aluminio de 3 palas con núcleo de goma de gran resistencia.
- 3 blade aluminum propeller with heavy duty rubber hub.
- Eliche di alluminio a 3 pale con mozzi in gomma ad alta resistenza.



SOLAS TITAN

- Hélice de acero inoxidable de tres palas.
- Alta curvatura y diseño para área grande.
- Gran capacidad para soportar gran carga.
- Excelente economía de combustible
- Three blade stainless steel propeller.
- High camber blade and large blade area design.
- Great load carrying capability.
- Excellent fuel economy.
- Eliche di acciaio inox a 3 pale.
- Grandi diametro e disegno delle pale per grande area.
- Ottima capacità di sopportare carichi pesanti.
- Eccellente risparmio di carburante.



SOLAS AMITA 4

- Hélices de aluminio de 4 palas con núcleo de goma de gran resistencia.
- Van muy suaves a poca velocidad y hace el barco muy manejable con la mar picada.
- 4 Blade aluminum propeller with heavy duty rubber hub.
- Smoother low speed makes the offshore boating activity much easier.
- Eliche di alluminio a 4 pale con mozzo in gomma ad alta resistenza.
- Molto morbido a bassa velocità e rende la barca molto maneggevole con mare cattivo.



SOLAS HR TITAN 3 PROP

- Hélice de acero inoxidable de 3 palas.
- Alto rendimiento para cascos de alta velocidad.
- La inclinación de la hoja proporciona un excelente elevación de proa y aceleración.
- El diseño de copa grande aumenta la mordida y reduce el deslizamiento.
- Three blade stainless steel propeller.
- Performance prop for high speed planning hulls.
- High rake blade design provides excellent bow lift and acceleration.
- Heavy cup design increases bite and reduces slip.
- Eliche di acciaio inox a 3 pale.
- Ad alte prestazioni per scafi ad alta velocità.
- Il passo della pala fornisce un'eccellente elevazione e accelerazione.
- Il disegno aumenta le prestazioni e riduce lo slittamento.

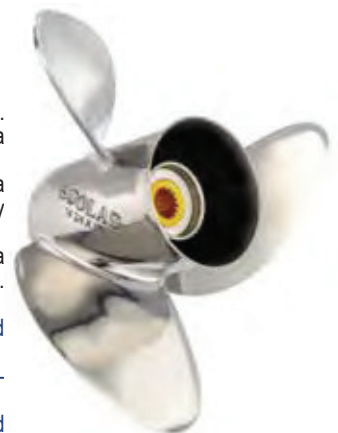

SOLAS NEW SATURN PROP

- Hélices de acero inoxidable de 3 palas.
- Ofrece buena aceleración y rendimiento.
- Tamaño más pequeño que ofrece un diámetro extragrande.
- Three blade stainless steel propeller.
- Offers good acceleration & all-round performance.
- Smaller pitch sizes offered in extra large diameter with increased blade area.
- Eliche di acciaio inox a 3 pale.
- Buona accelerazione.
- Piccole dimensione che offre un più grande diametro.



GUÍA DE HÉLICES ALUMINO E INOXIDABLES DE 3 Y 4 PALAS 3 & 4 BLADE ALUMINUM & STAINLESS STEEL PROPELLERS APPLICATION GUIDA ELICHE ALLUMINIO E INOX DA 3 E 4 PALE

HP	R.O. OEM	B	D	P	R	TIPO TYPE	ALUMINIO ALUMINIUM ALLUMINIO		INOX STAINLESS STEEL		
							AMITA 3	AMITA 4	NEW SATURN	TITAN	HR TITAN 3
BF2 Series	58130-ZV0-841ZB	3	7 1/4	6	R	Plastic	SOL6001-073-06P				
BF4		3	7 7/8	6 3/4	R	Alum	SOL6011-079-06P				
BF5		3	7 7/8	7 1/2	R	Alum	SOL6011-079-07P				
8 (01+)		3	9 1/4	7	R	Alum	SOL3111-093-07				
9.9 (88+)	58130-ZV4-703ZB	3	9 1/2	8 5/8	R	Alum	SOL3111-093-08				
15 (88+)	58130-ZV4-030ZB	3	9 1/2	9 1/2	R	Alum	SOL3111-093-09				
20 (03+)		3	9 1/4	10	R	Alum	SOL3111-093-10				
8 Estriás 8 tooth spline 8 denti		3	9 1/4	11	R	Alum	SOL3111-093-11				
25	58130-ZV7-850ZA	3	9 3/4	9 7/8	R	Alum	SOL5211-099-09				
30					R	Alum	SOL5211-099-10				
10 Estriás	58130-ZV7-000ZA	3	9 1/4	12	R	Alum	SOL5211-099-11				
10 tooth spline					R	Alum	SOL5211-099-12				
10 denti					R	Alum	SOL5211-099-13				
35 (91+)	58130-ZV5-860ZA	3	11 3/4	10	R	Alum	SOL3311-121-09				
40 (95+)	-				R	Alum	SOL3311-116-11				
45 (91-94)	58130-ZV5-850ZA	3	11 1/2	12	R	Alum	SOL3311-114-12				
BF40EFI	58130-ZV5-000ZA	3	11 1/4	13	R	Alum	SOL3311-111-13				
BF50EFI	58130-ZV5-870ZA	3	11 1/2	14	R	Alum	SOL3311-111-14				
BF60EFI	-				R	Alum	SOL3311-110-15				
50 (95+)	-	3	11	16	R	Alum	SOL3311-110-16				
13 Estriás		3	11	17	R	Alum	SOL3311-110-17				
13 tooth spline											
13 denti											
	58130-ZW1-W01ZA	3	14	11	R	Alum	SOL6411-140-11		SOL6431-140-11		
	58130-ZW1-W11ZA	3	13.75-13.25	13	R	Alum	SOL6411-138-13	SOL6413-133-13	SOL6431-138-13		
			13.5	14	R	Alum	SOL6411-135-14				
			13.5-13	15	R	Alum	SOL6411-135-15	SOL6413-130-15	SOL6431-135-15		
75 (1995+)	58130-ZW1-W31ZA	3	13.5	15	L	Alum	SOL6412-135-15				
90 (1995+)					R	Alum	SOL6411-133-17	SOL6413-128-17	SOL6431-133-17		
115 (1998-09)	58130-ZW1-W61ZA	3	13.25	17	L	Alum	SOL6412-133-17				
130 (1998-09)	58130-ZW1-W41ZA	3	13-12.5	19	R	Alum	SOL6411-130-19	SOL6413-125-19	SOL6431-130-19		
BFP60A					R	Alum	SOL6411-130-21	SOL6413-125-21	SOL6431-130-21		
15 Estriás	08M60-ZW7-A40	3	14 1/2	15	R	S/S			SOL1531-145-15		
15 tooth spline					R	S/S			SOL1531-143-17		
15 denti					R	S/S			SOL1531-140-19		
	08M60-ZW7-A00	3	14	19	R	S/S			SOL1531-140-19		
	08M60-ZW7-A10	3	14	21	R	S/S			SOL1531-140-21		
	08M60-ZW7-A20	3	14	23	R	S/S			SOL1531-140-23		
	08M60-ZW7-A30	3	14	25	R	S/S			SOL1531-140-25		
		3	15-14.75	15	R	S/S	SOL1511-150-15	SOL1513-148-15			
		3	15	15	L	S/S	SOL1512-150-15		SOL1532-145-15		
		3	14.8-14.5	17	R	S/S	SOL1511-148-17	SOL1513-145-17			
		3	14.8	17	L	S/S	SOL1512-148-17		SOL1532-143-17		
		3	14.5-14.25	19	R	S/S	SOL1511-145-19	SOL1513-143-19			
		3	14.5	19	L	S/S	SOL1512-145-19		SOL1532-140-19		
115 (2010+)		3	14	21	R	S/S		SOL1513-140-21			
130 (2010+)					R			SOL1513-140-23			
135 (2004+)		3	14.3	21	R	S/S	SOL1511-143-21				
150 (2004+)					L	S/S	SOL1512-143-21		SOL1532-140-21		
200 (2002+)		3	14.2	23	R	S/S	SOL1511-142-23				
225 (2002+)					L	S/S	SOL1512-142-23		SOL1532-140-23		
250 (2012+)		3	15 1/2-15 3/4	15	R				SOL1541-155-15	SOL1571-158-15	
		3	15 1/2-15 3/4	15	L				SOL1542-155-15	SOL1572-158-15	
		3	15 1/4-15 1/2	17	R				SOL1541-153-17	SOL1571-155-17	
		3	15 1/4-15 1/2	17	L				SOL1542-153-17	SOL1572-155-17	
		3	15-15 1/4	19	R				SOL1541-150-19	SOL1571-153-19	
		3	15-15 1/4	19	L				SOL1542-150-19	SOL1572-153-19	
		3	14 3/4-15	21	R				SOL1541-148-21	SOL1571-150-21	
		3	14 3/4-15	21	L				SOL1542-148-21	SOL1572-150-21	
		3	14 1/2-14 3/4	23	R				SOL1541-145-23	SOL1571-148-23	
		3	14 1/2-14 3/4	23	L				SOL1542-145-23	SOL1572-148-23	
		3	14 1/2	25	R					SOL1571-145-25	

B= PALAS / Blades / Pale
D= DIÁMETRO / Diametre / Diametro

R=ROTACIÓN / Rotation / Rotazione
(R) Derecha / Right / DX
(L) Izquierda / Left / SX

HONDA

RECAMBIOS
MARINOS S.L.

GUÍA DE NÚCLEOS HUB KIT APPLICATION CHAST GUIDA MOZZI INTERCAMBIABILI

SOLAS Altas prestaciones / núcleo de goma
Intercambiable con sistemas flo-torq & Vortex System.
Disponibile en acero inox y aluminio.

SOLAS High performance / Ruber Hub
Interchangeable with flo-torq & Vortex System.
Available in stainless Steel & Aluminium Propeller.

SOLAS Alte prestazioni / mozzo intercambiabile di gomma
con sistema flo-torq & Vortex System.
Disponibile in acciaio inox e alluminio.



RUBEX

MODELO MODEL MODELLO	REF. KIT	MODELO HÉLICE PROPELLER TYPE MODELLO ELICA
BF 35/45 1991-94; BF 40/50/50A (1995+) 13 Estrías / tooth spline / denti	RBX-113	C
75-90 HP (1995-1998) 13 Estrías / tooth spline / denti	RBX-102	D
75-90 HP (1999+) 115-130HP (1998+) 13 Estrías / tooth spline / denti	RBX-107	D
115-130HP (1998+) 15 Estrías / tooth spline / denti	RBX-107	D
BF135HP, 150HP, 200 / 225HP (2003+) BF250 15 Estrías / tooth spline / denti	RBX-107	E

GUÍA HÉLICES ALUMINIO PROPELLERS ALUMINUM CHART GUIDA ELICHE ALLUMINIO

Modelo / Model / Modello C 30-75 H.P. 3 PALAS / 3 BLADE / 3 PALE				
B	D	P	R	Ref.
3	12.1	9	R	SOL9311-121-09
3	12	10	R	SOL9311-120-10
3	11.6	11	R	SOL9311-116-11
3	11.4	12	R	SOL9311-114-12
3	11.1	13	R	SOL9311-111-13
3	11.1	14	R	SOL9311-111-14
3	11	15	R	SOL9311-110-15

Modelo / Model / Modello E 135-350 H.P. 3 PALAS / 3 BLADE / 3 PALE				
B	D	P	R	Ref.
3	15.5	11	R	SOL9511-155-11
3	15.3	13	R	SOL9511-153-13
3	16	13	R	SOL9511-160-13
3	15	15	R	SOL9511-150-15
3	15	15	L	SOL9511-150-15
3	14.8	17	R	SOL9511-148-17
3	14.8	17	L	SOL9511-148-17
3	14.5	19	R	SOL9511-145-19
3	14.5	19	L	SOL9511-145-19
3	14.3	21	R	SOL9511-143-21
3	14.3	21	L	SOL9511-143-21

Modelo / Model / Modello D 40-14 H.P. 3 PALAS / 3 BLADE / 3 PALE				
B	D	P	R	Ref.
3	14	9	R	SOL9411-140-09
3	14	11	R	SOL9411-140-11
3	13.75	13	R	SOL9411-138-12
3	13.5	15	R	SOL9411-135-15
3	13.25	17	R	SOL9411-133-17
3	13.2	19	R	SOL9411-132-19
3	13.2	21	R	SOL9411-132-21

RUBEX



Hélice de aluminio con núcleo intercambiable (no incluido).
Aluminium interchangeable hub propellers (not included).
Eliche in alluminio con mozzo intercambiabile (non incluso).

GUÍA HÉLICES INOX. STAINLESS STEEL PROPELLERS APLICATION CHART GUIDA ELICHE INOX

Modelo / Model / Modello **C** 30-75 H.P. 3 PALAS / 3 BLADE / 3 PALE

B	D	P	R	Ref.
3	11 5/8	11	R	SOL9331-116-11
3	11 3/8	12	R	SOL9331-114-12
3	11 1/8	13	R	SOL9331-111-13
3	11 1/8	14	R	SOL9331-111-14
3	11	15	R	SOL9331-110-15

Modelo / Model / Modello **D** 40-14 H.P. 3 PALAS / 3 BLADE / 3 PALE

B	D	P	R	Ref.
3	13 3/4	13	R	SOL9431-138-13
3	13 3/4	13	L	SOL9432-138-13
3	13 1/2	15	R	SOL9431-135-15
3	13 1/2	15	L	SOL9432-135-15
3	13 1/4	17	R	SOL9431-133-17
3	13 1/4	17	L	SOL9432-133-17
3	13	19	R	SOL9431-130-19
3	13	19	L	SOL9432-130-19
3	13	21	R	SOL9431-130-21

Modelo / Model / Modello **E** 90-140 H.P. 3 PALAS / 3 BLADE / 3 PALE

B	D	P	R	Ref.
3	14 1/2	15	R	SOL9531-145-15
3	14 1/2	15	L	SOL9532-145-15
3	14 1/4	17	R	SOL9531-143-17
3	14 1/4	17	L	SOL9532-143-17
3	14	19	R	SOL9531-140-19
3	14	19	L	SOL9532-140-19
3	14	21	R	SOL9531-140-21
3	14	21	L	SOL9532-140-21
3	14	23	R	SOL9531-140-23
3	14	23	L	SOL9532-140-23

Modelo / Model / Modello **E** 135-350 H.P. 3 PALAS / 3 BLADE / 3 PALE

B	D	P	R	Ref.
3	15 3/4	15	R	SOL9571-158-15
3	15 3/4	15	L	SOL9572-158-15
3	15 1/2	17	R	SOL9571-155-17
3	15 1/2	17	L	SOL9572-155-17
3	15 1/4	19	R	SOL9571-153-19
3	15 1/4	19	L	SOL9572-153-19
3	15	21	R	SOL9571-153-21
3	15	21	L	SOL9572-153-21
3	14 3/4	23	R	SOL9571-148-23
3	14 3/4	23	L	SOL9572-148-23
3	14 1/2	25	R	SOL9571-145-25
3	14 1/2	25	L	SOL9572-145-25

RUBEX



Hélice de acero inox. con núcleo intercambiable (no incluido).
Stainless steel interchangeable hub propellers (not included).
Eliche di acciaio inox con mozzo intercambiabile (nonn incluso).

HONDA